



6

RETTIG HEATING,

(812) 449-30-43

info@osma.su

PURMO

—

1

Purmo C (Compact)



ЗАСТРАХОВАНО НА
1 000 000 EURO



	EN 10130
	EN 10130
	:
	• • • • • •
	- 200 °C
	DIN 55900
	- RAL 9010
	1/2" ISO 228
	ISO 9001 ISO 14001
	0-110 °C
	10
	0,02 /
	7-9
	300, 400, 450, 500, 600, 900
	400-1200 (100), 1200-2000 (200), 2300, 2600, 3000
	52

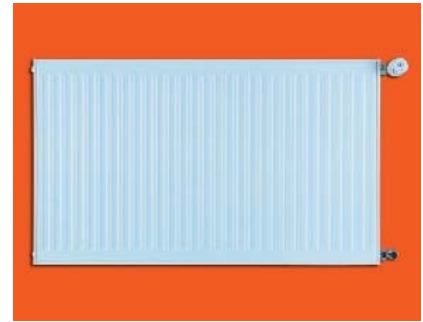

PURMO



400 - 1600
1800 - 3000

2
3

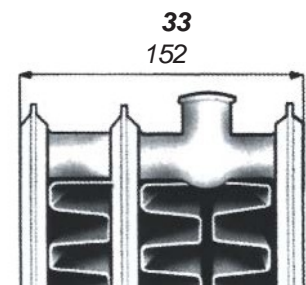
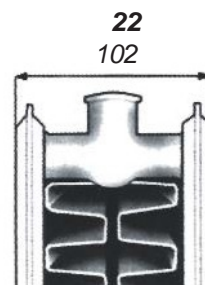
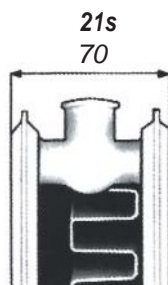
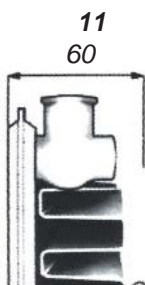
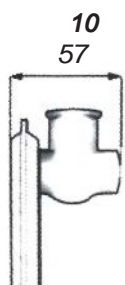

C10 -
C11 -
C21s -

C22 -
C33 -

EN 442 ()

: 90/70/20

	C 11				C 21s				C 22				
	265	382	420	495	370	513	559	650	476	656	715	832	
	398	574	630	742	555	770	839	976	714	984	1072	1247	
	531	765	840	989	740	1026	1119	1301	952	1312	1430	1663	
	663	956	1051	1236	925	1283	1398	1626	1190	1641	1787	2079	
	796	1147	1261	1484	1110	1539	1678	1951	1428	1969	2145	2495	
	929	1338	1471	1731	1295	1796	1958	2277	1666	2297	2502	2910	
	1061	1529	1681	1978	1480	2052	2237	2602	1904	2625	2860	3326	
	1194	1721	1891	2225	1665	2309	2517	2927	2142	2953	3217	3742	
	1327	1912	2101	2473	1850	2566	2797	3252	2380	3281	3575	4158	
	1990	2868	3152	3709	2774	3848	4195	4878	3570	4922	5362	6236	



PURMO



1.7.1997



(CEN),

-130

EN 442

1. : 01.07.1997.

EN 442-1.

2. : 2000.

CEN TC-130,
EN 442,

01.07.1996

EN 442-2.

3. : 2000.

EN 442-3

EN 442

EN 442,

- 1. EN 442-1
- 2. EN 442-2

70/40/20
32,7
35

- 3. EN 442-3

8%.

ISO 9002.

ISO 14001.

, 5. 1999

13 / ² (1,3).

7 9 0 120° ,
0,02 / .

10 / ² (1).

5-

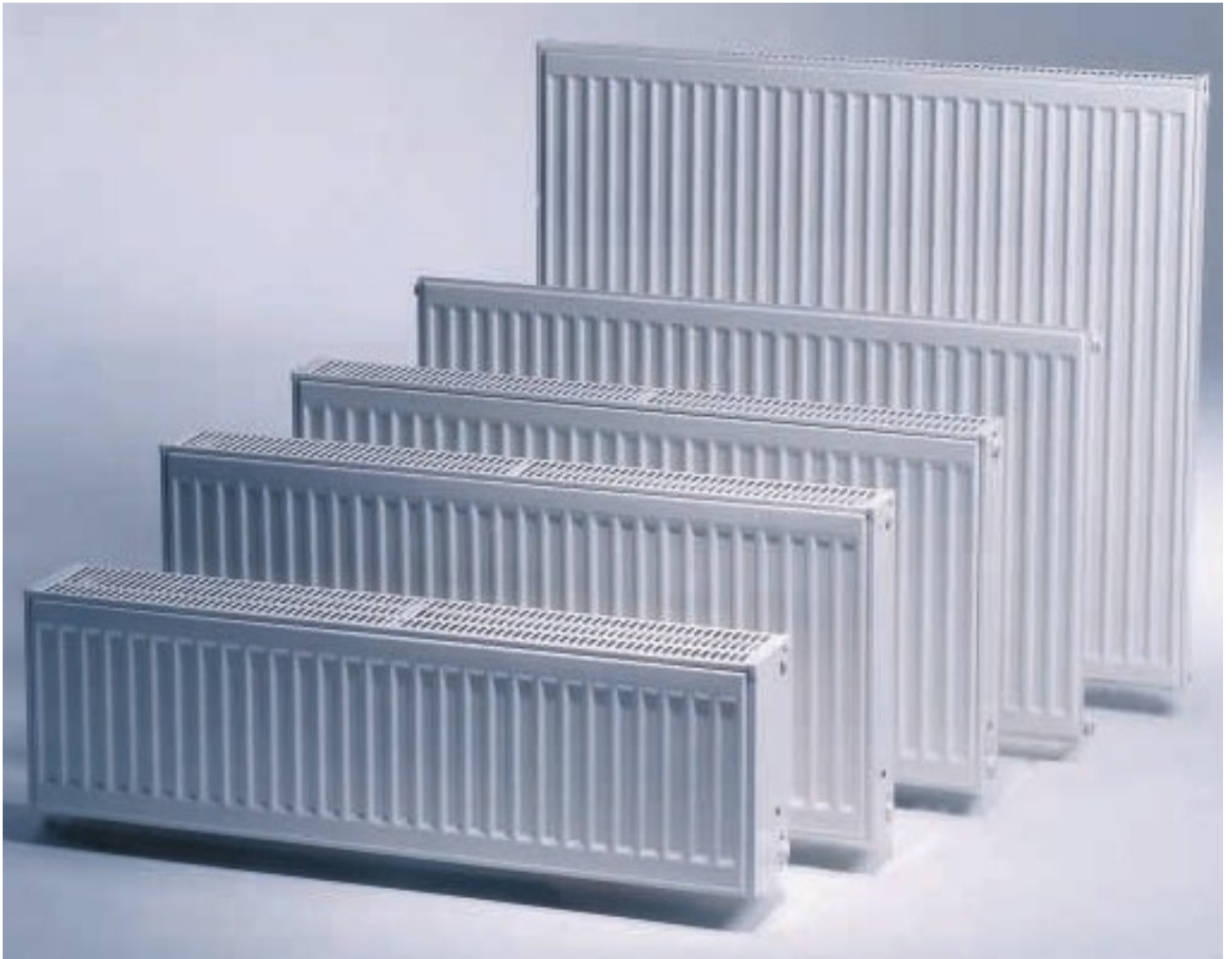

	:		EN 442-1 2		
	:			EN 10130	
	:	:	:	:	
			•		
			•		
			•		
			•		
			•		
				200°	
					DIN 55900
	:		RAL 9010, -		
	:		= 10 / ² (1)		
	:		ABFE, = 15 ,	4 1/2",	ISO 228
C	:		SFS-EN ISO 9002		
	:		300, 400, 450, 500, 600 900 ,		
	:		400 3 000 ,		
	:		10 -		
			11 - ,		
			21s - ,		
			22 - ,		
			33 - ,		

(/):

- PC 10 $\Phi = 5,8371 \times h^{0,86258} \times t^{(1,31620 - 0,01097 \times h)}$
- PC 11 $\Phi = 10,9231 \times h^{0,91848} \times t^{(1,27936 - 0,01139 \times h)}$
- PC 21s $\Phi = 11,9662 \times h^{0,76438} \times t^{(1,28110 + 0,02818 \times h)}$
- PC 22 $\Phi = 13,6077 \times h^{0,71525} \times t^{(1,29017 + 0,05057 \times h)}$
- PC 33 $\Phi = 20,6183 \times h^{0,93341} \times t^{(1,36684 - 0,05531 \times h)}$

$\Phi =$, /
 $h =$,
 $t =$,
 $t_m =$,
 $t_p =$,
 $t_h =$,

$$t = \frac{t_m - t_p}{\ln((t_m - t_h) / (t_p - t_h))}$$

70/40/20 =

= / /
 $t = 50^\circ\text{C}$.
 $t = 32,7^\circ\text{C}$.

: www.purmo.com/fi

EN 442

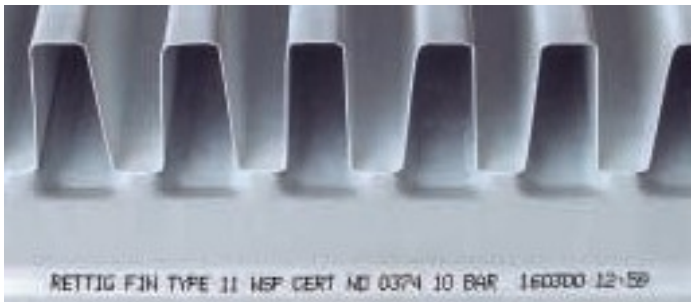

EN 442.

WSP Cert., : 10 = 0373, 11 = 0374,
 21s = 0384, 22 = 0376, 33 = 0377

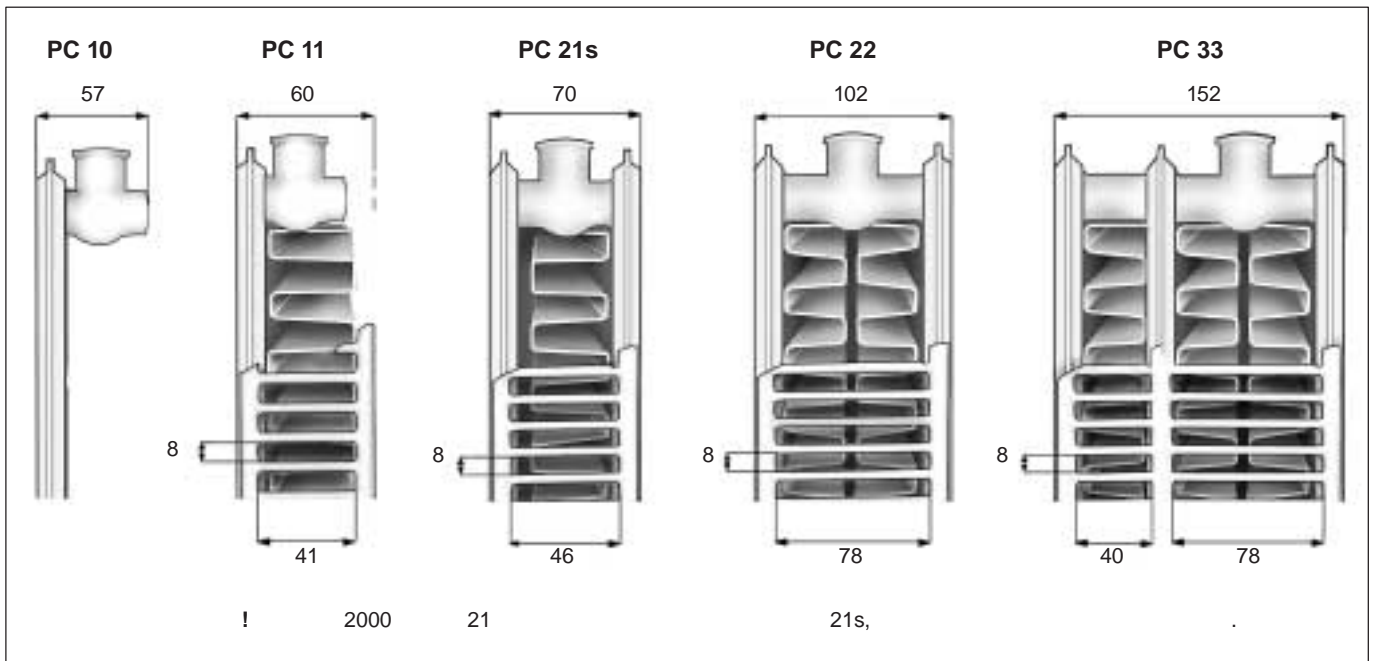

PC 10	300	5410802
	400	5410804
	450	5410806
	500	5410808
	600	5410810
	900	5410811
PC 11	300	5410812
	400	5410814
	450	5410816
	500	5410818
	600	5410820
	900	5410821
PC 21s-33	300	5410822
	400	5410824
	450	5410826
	500	5410828
	600	5410830
	900	5410831

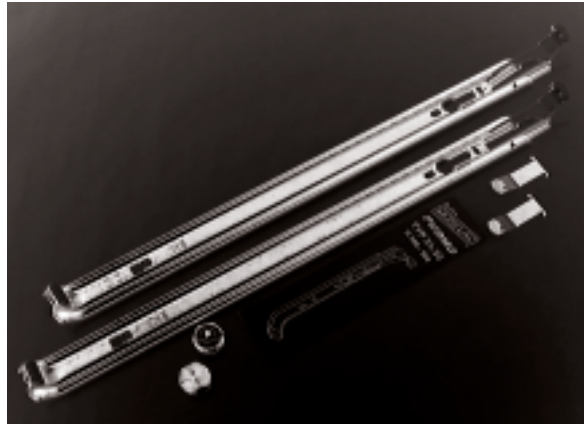

:2 ;
1/2"; 2

PC11-33	5410887
PC11	5410886

11



1800

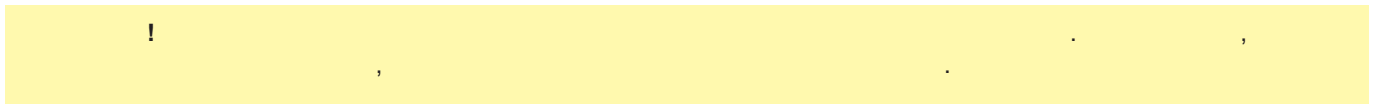
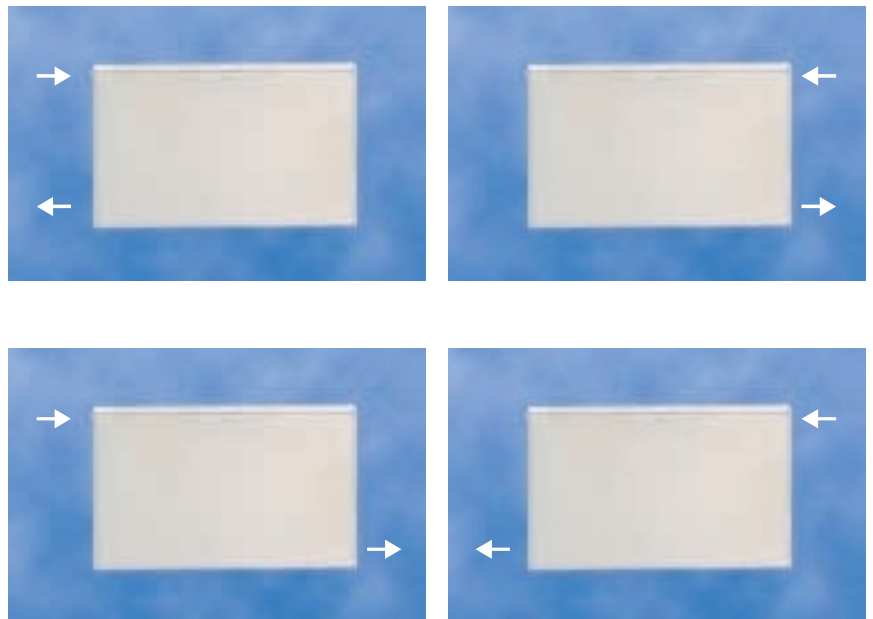
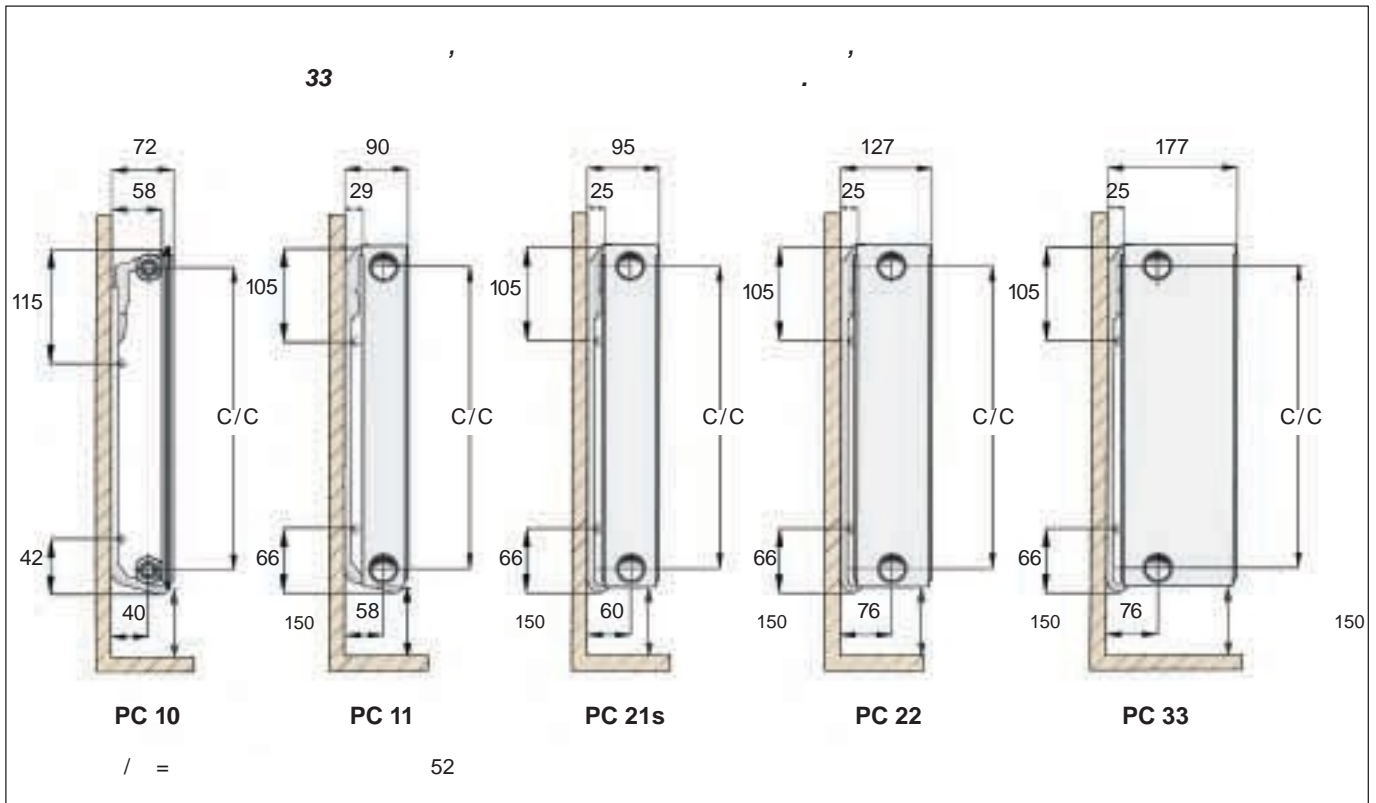

PC 10



				t = 50°C			
PC 10	300	400	5418002	141	3,2	0,8	
PC 10	300	500	5418003	176	3,8	1,0	
PC 10	300	600	5418004	211	4,4	1,1	
PC 10	300	700	5418005	246	5,0	1,2	
PC 10	300	800	5418006	281	5,6	1,4	
PC 10	300	900	5418007	316	6,2	1,5	
PC 10	300	1 000	5418008	351	6,8	1,7	
PC 10	300	1 100	5418009	387	7,4	1,8	
PC 10	300	1 200	5418010	422	8,0	1,9	
PC 10	300	1 400	5418012	492	9,2	2,2	
PC 10	300	1 600	5418013	562	10,4	2,5	

PC 11



				t = 50°C			
PC 11 x	300	400	5418202	213	4,6	0,8	
PC 11	300	500	5418203	266	5,4	1,0	
PC 11 x	300	600	5418204	319	6,3	1,1	
PC 11	300	700	5418205	372	7,1	1,2	
PC 11 x	300	800	5418206	426	8,0	1,4	
PC 11	300	900	5418207	479	8,8	1,5	
PC 11 x	300	1 000	5418208	532	9,7	1,7	
PC 11	300	1 100	5418209	585	10,5	1,8	
PC 11 x	300	1 200	5418210	638	11,4	1,9	
PC 11 x	300	1 400	5418212	745	13,0	2,2	
PC 11 x	300	1 600	5418213	851	14,7	2,5	
PC 11 x	300	1 800	5418214	958	16,4	2,8	
PC 11 x	300	2 000	5418215	1 064	18,1	3,1	
PC 11 x	300	2 300	5418216	1 224	20,6	3,5	
PC 11 x	300	2 600	5418217	1 383	23,2	3,9	
PC 11	300	3 000	5418218	1 596	26,5	4,5	

PC 21s



				t = 50°C			
PC 21s x	300	400	5418402	296	6,3	1,7	
PC 21s	300	500	5418403	370	7,7	2,0	
PC 21s x	300	600	5418404	444	9,1	2,3	
PC 21s	300	700	5418405	518	10,6	2,6	
PC 21s x	300	800	5418406	592	12,0	2,9	
PC 21s	300	900	5418407	666	13,4	3,1	
PC 21s x	300	1 000	5418408	740	14,8	3,4	
PC 21s	300	1 100	5418409	814	16,2	3,7	
PC 21s x	300	1 200	5418410	888	17,6	4,0	
PC 21s x	300	1 400	5418412	1 036	20,5	4,6	
PC 21s x	300	1 600	5418413	1 184	23,3	5,1	
PC 21s x	300	1 800	5418414	1 332	26,1	5,7	
PC 21s x	300	2 000	5418415	1 480	28,9	6,3	
PC 21s x	300	2 300	5418416	1 702	33,2	7,1	
PC 21s x	300	2 600	5418417	1 924	37,4	8,0	
PC 21s	300	3 000	5418418	2 220	43,1	9,1	

300

PC 22



				t = 50°C			
PC 22 x	300	400	5418602		380	7,7	1,7
PC 22	300	500	5418603		475	9,0	2,0
PC 22 x	300	600	5418604		570	10,4	2,3
PC 22	300	700	5418605		665	11,7	2,6
PC 22 x	300	800	5418606		760	13,1	2,9
PC 22	300	900	5418607		855	14,4	3,1
PC 22 x	300	1 000	5418608		950	15,7	3,4
PC 22	300	1 100	5418609		1 045	17,1	3,7
PC 22 x	300	1 200	5418610		1 139	18,4	4,0
PC 22 x	300	1 400	5418612		1 329	21,1	4,6
PC 22 x	300	1 600	5418613		1 519	23,7	5,1
PC 22 x	300	1 800	5418614		1 709	26,4	5,7
PC 22 x	300	2 000	5418615		1 899	29,1	6,3
PC 22 x	300	2 300	5418616		2 184	33,1	7,1
PC 22 x	300	2 600	5418617		2 469	37,1	8,0
PC 22	300	3 000	5418618		2 849	42,5	9,1

PC 33



				t = 50°C			
PC 33	300	400	5418802		528	11,1	2,5
PC 33	300	500	5418803		659	13,4	3,0
PC 33	300	600	5418804		791	15,7	3,4
PC 33	300	700	5418805		923	18,0	3,8
PC 33	300	800	5418806		1 055	20,3	4,2
PC 33	300	900	5418807		1 187	22,7	4,6
PC 33	300	1 000	5418808		1 319	25,0	5,0
PC 33	300	1 100	5418809		1 451	27,3	5,4
PC 33	300	1 200	5418810		1 583	29,6	5,8
PC 33	300	1 400	5418812		1 847	34,2	6,6
PC 33	300	1 600	5418813		2 110	38,9	7,4
PC 33	300	1 800	5418814		2 374	43,5	8,2
PC 33	300	2 000	5418815		2 638	48,1	9,1
PC 33	300	2 300	5418816		3 034	55,1	10,3
PC 33	300	2 600	5418817		3 429	62,0	11,5
PC 33	300	3 000	5418818		3 957	71,3	13,1

x -

t=50°C.

: www.purmo-com/fi

: -11-600-1200

! 2000

21s,

PC 10



				t = 50°C			
PC 10	400	400	5418022	179	3,9	1,0	
PC 10	400	500	5418023	224	4,7	1,2	
PC 10	400	600	5418024	269	5,5	1,4	
PC 10	400	700	5418025	314	6,3	1,5	
PC 10	400	800	5418026	359	7,1	1,7	
PC 10	400	900	5418027	404	7,9	1,9	
PC 10	400	1 000	5418028	448	8,7	2,1	
PC 10	400	1 100	5417029	493	9,5	2,3	
PC 10	400	1 200	5418030	538	10,3	2,5	
PC 10	400	1 400	5418032	628	11,9	2,9	
PC 10	400	1 600	5418033	717	13,5	3,3	

PC 11



				t = 50°C			
PC 11	400	400	5418222	276	5,8	1,0	
PC 11	400	500	5418223	345	7,0	1,2	
PC 11	400	600	5418224	414	8,2	1,4	
PC 11	400	700	5418225	483	9,3	1,5	
PC 11	400	800	5418226	552	10,5	1,7	
PC 11	400	900	5418227	621	11,7	1,9	
PC 11	400	1 000	5418228	690	12,8	2,1	
PC 11	400	1 100	5418229	759	14,0	2,3	
PC 11	400	1 200	5418230	828	15,1	2,5	
PC 11	400	1 400	5418232	966	17,5	2,9	
PC 11	400	1 600	5418233	1 104	19,8	3,3	
PC 11	400	1 800	5418234	1 242	22,1	3,6	
PC 11	400	2 000	5418235	1 380	24,4	4,0	
PC 11	400	2 300	5418236	1 586	27,9	4,6	
PC 11	400	2 600	5418237	1 793	31,4	5,2	
PC 11	400	3 000	5418238	2 069	36,1	5,9	

PC 21s



				t = 50°C			
PC 21s	400	400	5418422	373	8,2	2,1	
PC 21s	400	500	5418423	466	10,1	2,4	
PC 21s	400	600	5418424	559	12,0	2,8	
PC 21s	400	700	5418425	652	13,9	3,2	
PC 21s	400	800	5418426	746	15,7	3,6	
PC 21s	400	900	5418427	839	17,6	4,0	
PC 21s	400	1 000	5418428	932	19,5	4,3	
PC 21s	400	1 100	5418429	1 025	21,3	4,7	
PC 21s	400	1 200	5418430	1 119	23,2	5,1	
PC 21s	400	1 400	5418432	1 305	27,0	5,9	
PC 21s	400	1 600	5418433	1 491	30,7	6,6	
PC 21s	400	1 800	5418434	1 678	34,4	7,4	
PC 21s	400	2 000	5418435	1 864	38,2	8,1	
PC 21s	400	2 300	5418436	2 144	43,8	9,3	
PC 21s	400	2 600	5418437	2 424	49,4	10,4	
PC 21s	400	3 000	5418438	2 796	56,9	11,9	

400

PC 22



				t = 50°C			
PC 22	400	400	5418622		476	9,8	2,1
PC 22	400	500	5418623		595	11,7	2,4
PC 22	400	600	5418624		714	13,7	2,8
PC 22	400	700	5418625		833	15,6	3,2
PC 22	400	800	5418626		952	17,6	3,6
PC 22	400	900	5418627		1 071	19,5	4,0
PC 22	400	1 000	5418628		1 190	21,5	4,3
PC 22	400	1 100	5418629		1 309	23,4	4,7
PC 22	400	1 200	5418630		1 428	25,3	5,1
PC 22	400	1 400	5418632		1 666	29,2	5,9
PC 22	400	1 600	5418633		1 904	33,1	6,6
PC 22	400	1 800	5418634		2 142	37,0	7,4
PC 22	400	2 000	5418635		2 380	40,9	8,1
PC 22	400	2 300	5418636		2 737	46,7	9,3
PC 22	400	2 600	5418637		3 094	52,5	10,4
PC 22	400	3 000	5418638		3 569	60,3	11,9

PC 33



				t = 50°C			
PC 33	400	400	5418822		675	14,3	3,1
PC 33	400	500	5418823		844	17,4	3,6
PC 33	400	600	5418824		1 013	20,6	4,2
PC 33	400	700	5418825		1 182	23,8	4,7
PC 33	400	800	5418826		1 351	26,9	5,2
PC 33	400	900	5418827		1 519	30,1	5,8
PC 33	400	1 000	5418828		1 688	33,3	6,3
PC 33	400	1 100	5418829		1 857	36,4	6,9
PC 33	400	1 200	5418830		2 026	39,6	7,4
PC 33	400	1 400	5418832		2 364	45,9	8,5
PC 33	400	1 600	5418833		2 701	52,2	9,6
PC 33	400	1 800	5418834		3 039	58,5	10,7
PC 33	400	2 000	5418835		3 377	64,9	11,8
PC 33	400	2 300	5418836		3 883	74,3	13,4
PC 33	400	2 600	5418837		4 390	83,8	15,0
PC 33	400	3 000	5418838		5 065	96,5	17,2

x -

t=50°C.

: www.purmo-com/fi

: -11-600-1200

! 2000

21s,

PC 10



				t = 50°C			
PC 10	450	400	5418042	198	4,3	1,1	
PC 10	450	500	5418043	248	5,2	1,3	
PC 10	450	600	5418044	297	6,1	1,5	
PC 10	450	700	5418045	347	7,0	1,7	
PC 10	450	800	5418046	396	7,9	1,9	
PC 10	450	900	5418047	446	8,8	2,1	
PC 10	450	1 000	5418048	495	9,7	2,3	
PC 10	450	1 100	5418049	545	10,6	2,6	
PC 10	450	1 200	5418050	594	11,5	2,8	
PC 10	450	1 400	5418052	693	13,3	3,2	
PC 10	450	1 600	5418053	792	15,1	3,6	

PC 11



				t = 50°C			
PC 11 x	450	400	5418242	307	6,5	1,1	
PC 11	450	500	5418243	383	7,8	1,3	
PC 11 x	450	600	5418244	460	9,1	1,5	
PC 11	450	700	5418245	537	10,4	1,7	
PC 11 x	450	800	5418246	613	11,7	1,9	
PC 11	450	900	5418247	690	13,1	2,1	
PC 11 x	450	1 000	5418248	767	14,4	2,3	
PC 11	450	1 100	5418249	844	15,7	2,6	
PC 11 x	450	1 200	5418250	920	17,0	2,8	
PC 11 x	450	1 400	5418252	1 074	19,7	3,2	
PC 11 x	450	1 600	5418253	1 227	22,3	3,6	
PC 11 x	450	1 800	5418254	1 380	25,0	4,1	
PC 11 x	450	2 000	5418255	1 534	27,6	4,5	
PC 11 x	450	2 300	5418256	1 764	31,6	5,1	
PC 11 x	450	2 600	5418257	1 994	35,6	5,8	
PC 11	450	3 000	5418258	2 301	40,8	6,6	

PC 21s



				t = 50°C			
PC 21s x	450	400	5418442	410	9,2	2,2	
PC 21s	450	500	5418443	513	11,3	2,7	
PC 21s x	450	600	5418444	615	13,4	3,1	
PC 21s	450	700	5418445	718	15,5	3,5	
PC 21s x	450	800	5418446	820	17,6	3,9	
PC 21s	450	900	5418447	923	19,7	4,4	
PC 21s x	450	1 000	5418448	1 026	21,8	4,8	
PC 21s	450	1 100	5418449	1 128	23,9	5,2	
PC 21s x	450	1 200	5418450	1 231	26,0	5,6	
PC 21s x	450	1 400	5418452	1 436	30,2	6,5	
PC 21s x	450	1 600	5418453	1 641	34,4	7,4	
PC 21s x	450	1 800	5418454	1 846	38,6	8,2	
PC 21s x	450	2 000	5418455	2 051	42,8	9,1	
PC 21s x	450	2 300	5418456	2 359	49,1	10,3	
PC 21s x	450	2 600	5418457	2 667	55,4	11,6	
PC 21s	450	3 000	5418458	3 077	63,8	13,3	

450

PC 22



				t = 50°C			
PC 22 x	450	400	5418642		523	10,9	2,2
PC 22	450	500	5418643		654	13,1	2,7
PC 22 x	450	600	5418644		784	15,3	3,1
PC 22	450	700	5418645		915	17,6	3,5
PC 22 x	450	800	5418646		1 046	19,8	3,9
PC 22	450	900	5418647		1 177	22,1	4,4
PC 22 x	450	1 000	5418648		1 307	24,3	4,8
PC 22	450	1 100	5418649		1 438	26,6	5,2
PC 22 x	450	1 200	5418650		1 569	28,8	5,6
PC 22 x	450	1 400	5418652		1 830	33,3	6,5
PC 22 x	450	1 600	5418653		2 092	37,8	7,4
PC 22 x	450	1 800	5418654		2 353	42,3	8,2
PC 22 x	450	2 000	5418655		2 615	46,7	9,1
PC 22 x	450	2 300	5418656		3 007	53,5	10,3
PC 22 x	450	2 600	5418657		3 399	60,2	11,6
PC 22	450	3 000	5418658		3 922	69,2	13,3

PC 33



				t = 50°C			
PC 33	450	400	5418842		746	15,9	3,3
PC 33	450	500	5418843		932	19,5	3,9
PC 33	450	600	5418844		1 119	23,1	4,6
PC 33	450	700	5418845		1 305	26,6	5,2
PC 33	450	800	5418846		1 491	30,2	5,8
PC 33	450	900	5418847		1 678	33,8	6,4
PC 33	450	1 000	5418848		1 864	37,4	7,0
PC 33	450	1 100	5418849		2 051	41,0	7,6
PC 33	450	1 200	5418850		2 237	44,6	8,2
PC 33	450	1 400	5418852		2 610	51,7	9,4
PC 33	450	1 600	5418853		2 983	58,9	10,7
PC 33	450	1 800	5418854		3 356	66,0	11,9
PC 33	450	2 000	5418855		3 728	73,2	13,1
PC 33	450	2 300	5418856		4 288	84,0	14,9
PC 33	450	2 600	5418857		4 847	94,7	16,8
PC 33	450	3 000	5418858		5 593	109,0	19,2

x -

t=50°C.

: www.purmo-com/fi

: -11-600-1200

! 2000

21s,

PC 10



				t = 50°C			
PC 10	500	400	5418062	217	4,7	1,1	
PC 10	500	500	5418063	271	5,7	1,4	
PC 10	500	600	5418064	325	6,7	1,6	
PC 10	500	700	5418065	379	7,7	1,9	
PC 10	500	800	5418066	433	8,7	2,1	
PC 10	500	900	5418067	487	9,7	2,3	
PC 10	500	1 000	5418068	541	10,7	2,6	
PC 10	500	1 100	5418069	595	11,6	2,8	
PC 10	500	1 200	5418070	650	12,6	3,0	
PC 10	500	1 400	5418072	758	14,6	3,5	
PC 10	500	1 600	5418073	866	16,6	4,0	

PC 11

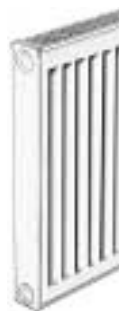

				t = 50°C			
PC 11	500	400	5418262	337	7,1	1,1	
PC 11	500	500	5418263	421	8,5	1,4	
PC 11	500	600	5418264	506	10,0	1,6	
PC 11	500	700	5418265	590	11,5	1,9	
PC 11	500	800	5418266	674	13,0	2,1	
PC 11	500	900	5418267	759	14,5	2,3	
PC 11	500	1 000	5418268	843	16,0	2,6	
PC 11	500	1 100	5418269	927	17,4	2,8	
PC 11	500	1 200	5418270	1 011	18,9	3,0	
PC 11	500	1 400	5418272	1 180	21,9	3,5	
PC 11	500	1 600	5418273	1 349	24,9	4,0	
PC 11	500	1 800	5418274	1 517	27,8	4,5	
PC 11	500	2 000	5418275	1 686	30,8	4,9	
PC 11	500	2 300	5418276	1 939	35,2	5,7	
PC 11	500	2 600	5418277	2 192	39,7	6,4	
PC 11	500	3 000	5418278	2 529	45,6	7,3	

PC 21s



				t = 50°C			
PC 21s	500	400	5418462	447	10,2	2,4	
PC 21s	500	500	5418463	559	12,5	2,9	
PC 21s	500	600	5418464	671	14,8	3,3	
PC 21s	500	700	5418465	782	17,2	3,8	
PC 21s	500	800	5418466	894	19,5	4,3	
PC 21s	500	900	5418467	1 006	21,8	4,8	
PC 21s	500	1 000	5418468	1 118	24,1	5,2	
PC 21s	500	1 100	5418469	1 230	26,5	5,7	
PC 21s	500	1 200	5418470	1 341	28,8	6,2	
PC 21s	500	1 400	5418472	1 565	33,5	7,1	
PC 21s	500	1 600	5418473	1 788	38,1	8,1	
PC 21s	500	1 800	5418474	2 012	42,8	9,0	
PC 21s	500	2 000	5418475	2 235	47,4	10,0	
PC 21s	500	2 300	5418476	2 571	54,4	11,4	
PC 21s	500	2 600	5418477	2 906	61,4	12,8	
PC 21s	500	3 000	5418478	3 353	70,7	14,7	

500

PC 22



				t = 50°C			
PC 22	500	400	5418662		569	11,9	2,4
PC 22	500	500	5418663		712	14,5	2,9
PC 22	500	600	5418664		854	17,0	3,3
PC 22	500	700	5418665		997	19,5	3,8
PC 22	500	800	5418666		1 139	22,1	4,3
PC 22	500	900	5418667		1 281	24,6	4,8
PC 22	500	1 000	5418668		1 424	27,2	5,2
PC 22	500	1 100	5418669		1 566	29,7	5,7
PC 22	500	1 200	5418670		1 708	32,3	6,2
PC 22	500	1 400	5418672		1 993	37,4	7,1
PC 22	500	1 600	5418673		2 278	42,5	8,1
PC 22	500	1 800	5418674		2 563	47,5	9,0
PC 22	500	2 000	5418675		2 847	52,6	10,0
PC 22	500	2 300	5418676		3 274	60,3	11,4
PC 22	500	2 600	5418677		3 701	67,9	12,8
PC 22	500	3 000	5418678		4 271	78,1	14,7

PC 33



				t = 50°C			
PC 33	500	400	5418862		814	17,5	3,6
PC 33	500	500	5418863		1 017	21,5	4,3
PC 33	500	600	5418864		1 221	25,5	5,0
PC 33	500	700	5418865		1 424	29,5	5,6
PC 33	500	800	5418866		1 628	33,5	6,3
PC 33	500	900	5418867		1 831	37,5	7,0
PC 33	500	1 000	5418868		2 035	41,5	7,7
PC 33	500	1 100	5418869		2 238	45,5	8,3
PC 33	500	1 200	5418870		2 442	49,5	9,0
PC 33	500	1 400	5418872		2 849	57,5	10,4
PC 33	500	1 600	5418873		3 256	65,6	11,7
PC 33	500	1 800	5418874		3 662	73,6	13,1
PC 33	500	2 000	5418875		4 069	81,6	14,5
PC 33	500	2 300	5418876		4 680	93,6	16,5
PC 33	500	2 600	5418877		5 290	105,6	18,5
PC 33	500	3 000	5418878		6 104	121,6	21,2

x -

t=50°C.

: www.purmo-com/fi

: -11-600-1200

! 2000

21s,

PC 10



				t = 50°C			
PC 10	600	400	5418082	252	5,5	1,3	
PC 10	600	500	5418083	315	6,7	1,6	
PC 10	600	600	5418084	378	7,8	1,9	
PC 10	600	700	5418085	442	9,0	2,2	
PC 10	600	800	5418086	505	10,2	2,5	
PC 10	600	900	5418087	568	11,4	2,7	
PC 10	600	1 000	5418088	631	12,6	3,0	
PC 10	600	1 100	5418089	694	13,8	3,3	
PC 10	600	1 200	5418090	757	15,0	3,6	
PC 10	600	1 400	5418092	883	17,3	4,2	
PC 10	600	1 600	5418093	1 009	19,7	4,7	

PC 11



				t = 50°C			
PC 11 x	600	400	5418282	397	8,3	1,3	
PC 11	600	500	5418283	496	10,1	1,6	
PC 11 x	600	600	5418284	595	11,9	1,9	
PC 11	600	700	5418285	694	13,7	2,2	
PC 11 x	600	800	5418286	794	15,5	2,5	
PC 11	600	900	5418287	893	17,3	2,7	
PC 11 x	600	1 000	5418288	992	19,1	3,0	
PC 11	600	1 100	5418289	1 091	20,9	3,3	
PC 11 x	600	1 200	5418290	1 191	22,7	3,6	
PC 11 x	600	1 400	5418292	1 389	26,3	4,2	
PC 11 x	600	1 600	5418293	1 587	29,9	4,7	
PC 11 x	600	1 800	5418294	1 786	33,5	5,3	
PC 11 x	600	2 000	5418295	1 984	37,1	5,9	
PC 11 x	600	2 300	5418296	2 282	42,5	6,7	
PC 11 x	600	2 600	5418297	2 580	47,9	7,6	
PC 11	600	3 000	5418298	2 976	55,1	8,7	

PC 21s



				t = 50°C			
PC 21s x	600	400	5418482	520	12,1	2,7	
PC 21s	600	500	5418483	650	14,9	3,3	
PC 21s x	600	600	5418484	779	17,7	3,9	
PC 21s	600	700	5418485	909	20,5	4,4	
PC 21s x	600	800	5418486	1 039	23,2	5,0	
PC 21s	600	900	5418487	1 169	26,0	5,6	
PC 21s x	600	1 000	8418488	1 299	28,8	6,2	
PC 21s	600	1 100	5418489	1 429	31,6	6,7	
PC 21s x	600	1 200	5418490	1 559	34,4	7,3	
PC 21s x	600	1 400	5418492	1 819	40,0	8,4	
PC 21s x	600	1 600	5418493	2 079	45,5	9,6	
PC 21s x	600	1 800	5418494	2 338	51,1	10,7	
PC 21s x	600	2 000	5418495	2 598	56,7	11,8	
PC 21s x	600	2 300	5418496	2 988	65,0	13,6	
PC 21s x	600	2 600	5418497	3 378	73,4	15,3	
PC 21s	600	3 000	5418498	3 897	84,5	17,5	

600

PC 22



				t = 50°C			
PC 22 x	600	400	5418682		662	14,0	2,7
PC 22	600	500	5418683		827	17,2	3,3
PC 22 x	600	600	5418684		993	20,3	3,9
PC 22	600	700	5418685		1 158	23,5	4,4
PC 22 x	600	800	5418686		1 323	26,6	5,0
PC 22	600	900	5418687		1 489	29,8	5,6
PC 22 x	600	1 000	5418688		1 654	32,9	6,2
PC 22	600	1 100	5418689		1 820	36,1	6,7
PC 22 x	600	1 200	5418690		1 985	39,2	7,3
PC 22 x	600	1 400	5418692		2 316	45,5	8,4
PC 22 x	600	1 600	5418693		2 647	51,8	9,6
PC 22 x	600	1 800	5418694		2 978	58,1	10,7
PC 22 x	600	2 000	5418695		3 309	64,4	11,8
PC 22 x	600	2 300	5418696		3 805	73,8	13,6
PC 22 x	600	2 600	5418697		4 301	83,3	15,3
PC 22	600	3 000	5418698		4 963	95,9	17,5

PC 33



				t = 50°C			
PC 33	600	400	5418882		944	20,7	4,1
PC 33	600	500	5418883		1 180	25,6	4,9
PC 33	600	600	5418884		1 416	30,4	5,7
PC 33	600	700	5418885		1 652	35,3	6,6
PC 33	600	800	5418886		1 888	40,1	7,4
PC 33	600	900	5418887		2 125	45,0	8,2
PC 33	600	1 000	5418888		2 361	49,8	9,0
PC 33	600	1 100	5418889		2 597	54,7	9,8
PC 33	600	1 200	5418890		2 833	59,5	10,6
PC 33	600	1 400	5418892		3 305	69,2	12,3
PC 33	600	1 600	5418893		3 777	78,9	13,9
PC 33	600	1 800	5418894		4 249	88,6	15,5
PC 33	600	2 000	5418895		4 721	98,3	17,1
PC 33	600	2 300	5418896		5 429	112,8	19,6
PC 33	600	2 600	5418897		6 137	127,4	22,0
PC 33	600	3 000	5418898		7 082	146,8	25,3

x -

t=50°C.

: www.purmo-com/fi

: -11-600-1200

! 2000

21s,

PC 11



				t = 50°C			
PC 11	900	400	5418302		568	12,0	1,8
PC 11	900	500	5418303		710	14,8	2,3
PC 11	900	600	5418304		852	17,5	2,7
PC 11	900	700	5418305		994	20,3	3,1
PC 11	900	800	5418306		1 137	23,0	3,5
PC 11	900	900	5418307		1 279	25,8	4,0
PC 11	900	1 000	5418308		1 421	28,6	4,4
PC 11	900	1 100	5418309		1 563	31,3	4,8
PC 11	900	1 200	5418310		1 705	34,1	5,2
PC 11	900	1 400	5418312		1 989	39,6	6,1
PC 11	900	1 600	5418313		2 273	45,1	7,0
PC 11	900	1 800	5418314		2 557	50,6	7,8
PC 11	900	2 000	5418315		2 841	56,2	8,7
PC 11	900	2 300	5418316		3 268	64,4	9,9
PC 11	900	2 600	5418317		3 694	72,7	11,2
PC 11	900	3 000	5418318		4 262	83,8	12,9

PC 21s



				t = 50°C			
PC 21s	900	400	5418502		732	17,9	3,7
PC 21s	900	500	5418503		915	22,0	4,6
PC 21s	900	600	5418504		1 098	26,2	5,5
PC 21s	900	700	5418505		1 281	30,4	6,3
PC 21s	900	800	5418506		1 465	34,5	7,2
PC 21s	900	900	5418507		1 648	38,7	8,0
PC 21s	900	1 000	5418508		1 831	42,8	8,9
PC 21s	900	1 100	5418509		2 014	47,0	9,7
PC 21s	900	1 200	5418510		2 197	51,2	10,6
PC 21s	900	1 400	5418512		2 563	59,5	12,3
PC 21s	900	1 600	5418513		2 929	67,8	14,0
PC 21s	900	1 800	5418514		3 295	76,1	15,7
PC 21s	900	2 000	5418515		3 661	84,4	17,4
PC 21s	900	2 300	5418516		4 211	96,9	20,0
PC 21s	900	2 600	5418517		4 760	109,4	22,5
PC 21s	900	3 000	5418518		5 492	126,0	26,0

900

PC 22



				t = 50°C			
PC 22	900	400	5418702		938	20,3	3,7
PC 22	900	500	5418703		1 173	25,3	4,6
PC 22	900	600	5418704		1 408	30,3	5,5
PC 22	900	700	5418705		1 642	35,2	6,3
PC 22	900	800	5418706		1 877	40,2	7,2
PC 22	900	900	5418707		2 111	45,1	8,0
PC 22	900	1 000	5418708		2 346	50,1	8,9
PC 22	900	1 100	5418709		2 581	55,1	9,7
PC 22	900	1 200	5418710		2 815	60,0	10,6
PC 22	900	1 400	5418712		3 285	69,9	12,3
PC 22	900	1 600	5418713		3 754	79,9	14,0
PC 22	900	1 800	5418714		4 223	89,8	15,7
PC 22	900	2 000	5418715		4 692	99,7	17,4
PC 22	900	2 300	5418716		5 396	114,6	20,0
PC 22	900	2 600	5418717		6 100	129,5	22,5
PC 22	900	3 000	5418718		7 038	149,3	26,0

PC 33



				t = 50°C			
PC 33	900	400	5418902		1 292	30,4	5,7
PC 33	900	500	5418903		1 615	37,7	6,9
PC 33	900	600	5418904		1 938	45,1	8,1
PC 33	900	700	5418905		2 261	52,5	9,4
PC 33	900	800	5418906		2 584	59,9	10,6
PC 33	900	900	5418907		2 907	67,3	11,8
PC 33	900	1 000	5418908		3 230	74,6	13,0
PC 33	900	1 100	5418909		3 553	82,0	14,2
PC 33	900	1 200	5418910		3 876	89,4	15,5
PC 33	900	1 400	5418912		4 522	104,2	17,9
PC 33	900	1 600	5418913		5 168	118,9	20,3
PC 33	900	1 800	5418914		5 814	133,7	22,8
PC 33	900	2 000	5418915		6 460	148,4	25,2
PC 33	900	2 300	5418916		7 429	170,6	28,9
PC 33	900	2 600	5418917		8 398	192,7	32,6
PC 33	900	3 000	5418918		9 690	222,2	37,4

x -

t=50°C.

: www.purmo-com/fi

: -11-600-1200

! 2000

21s,

www.purmo.com/fi

<http://osma.su/>

/ 16

FIN-68601

.: +358-6-786 9111

: +358-6-786 9222

myynti.pietarsaari@rettigheating.com

: ООО «Компания ОСМА»

: 190005, Санкт-Петербург, наб. Обводного
канала, д. 118, литер С, пом. 1-Н

/ : 7839474212/783901001

: АКБ «АВАНГАРД» (ОАО)

. : 40702810502100019937

. : 3010181000000000201

: 044525201

Тел./факс: (812) 449-30-43

(812) 449-30-44